

SFPR9604NR

90CM DOLCE STIL NOVO THERMOSEAL OVEN

MADE IN ITALY

Since 1948

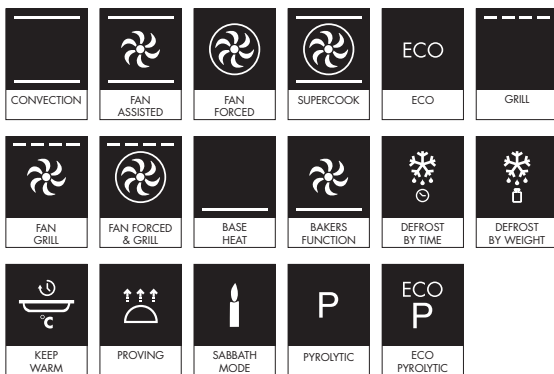
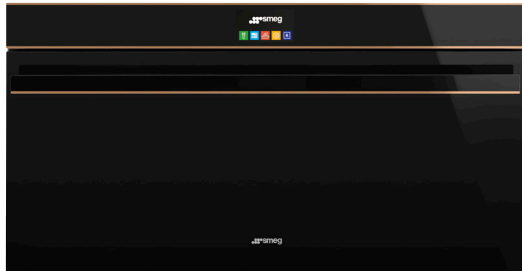

Dimensions	896mmW x 571mmD x 475mmH
Finish	Black eclipse glass with copper trim
Total functions	17 + 50 SmartSense Plus auto menus incl. Sabbath mode, defrost, proving and keep warm
Warranty	Five years parts and labour

Colours Available

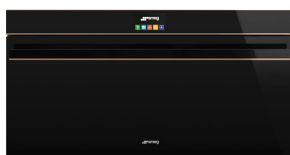

SFPR9604NR
Copper Trim

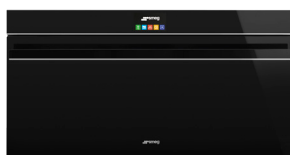

SFPR9604NX
Stainless Steel Trim

THERMOSEAL

The seal of Smeg's quality, technical excellence and taste: succulent roasts, crisp pastry and impressive baking is achieved in Smeg's unique, perfectly controlled cooking environment. Thermoseal maintains the perfect atmospheric balance in the cavity for optimum cooking conditions.

SMARTSENSE PLUS

Smeg's SmartSense Plus provides a foolproof, step-by-step guide to cooking. The large TFT colour display is clearly legible and simple to follow. SmartSense Plus also has 50 guided cooking programs and you can also save 10 of your most-used favourites.

TRIPLE FAN

Engineered for optimum performance, Smeg's triple fan circulates air efficiently throughout the oven cavity for even cooking and browning. Retaining heat within, it seals in the flavour of all your favourite meals.

SOFT CLOSE DOOR

The new soft-close mechanism on Smeg's oven doors ensures a two-stage soft and quiet close. Smeg's quality hinges also ensure the door will not drop on opening, an intrinsic safety feature.

PYROLYTIC CLEANING

Smeg's pyrolytic cycle locks the door and heats the oven to around 500°C. This process carbonises food residue or burnt-on grease to a small amount of ash, which can be simply wiped away. Smeg also has Eco Pyro – to reduce energy consumption.

EVER CLEAN ENAMEL

The superior quality of Smeg's signature Ever Clean enamel, which is highly durable and easy to clean, is the result of nearly 70 years of enameling expertise; ensuring long-life performance of every Smeg oven.

SFPR9604NR

90CM DOLCE STIL NOVO THERMOSEAL OVEN

MADE IN ITALY

Since 1948

OVEN FEATURES

Dimensions	896mmW x 571mmD x 475mmH
Finish	Black eclipse glass with copper trim
Total functions	17 + 50 SmartSense Plus auto menus incl. Sabbath mode, defrost, proving and keep warm
Auto menus	50 SmartSense Plus menus
Display	Colour Touch TFT
Cavity	Ever Clean Enamel
Capacity	100L
Cooking levels	4
Thermostat	30-280°C
Installation	Built-in
Programmability	Fully programmable
Cleaning	Vapour Clean
Lighting	2 x 40W halogen
Safety	Cool Door technology, thermal protection system, child safety lock, controls lock
Power	220-240V, 50/60Hz 3300W 15A Connection
Warranty	Five years parts and labour

OVEN FUNCTIONS

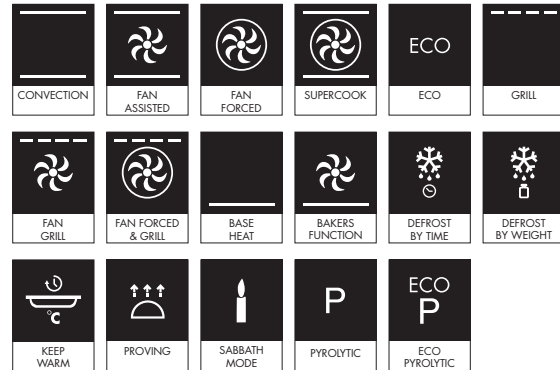

SUPPLIED ACCESSORIES

- 1 x Chrome grill insert
- 1 x Chrome shelves
- 1 x 40mm enamelled baking tray
- 1 x Full telescopic guides

OPTIONAL ACCESSORIES

- PPR9 - Pizza Stone
- PPR2 - Gourmet Cooking Stone
- PALPZ - Single-handle pizza paddle
- 38508/510 - Baking Dish
- GT1P-2 - Partial telescopic guides
- GT1T-2 - Total telescopic guides

SFPR9604NR

90CM DOLCE STIL NOVO THERMOSEAL OVEN

MADE IN ITALY

 Since 1948

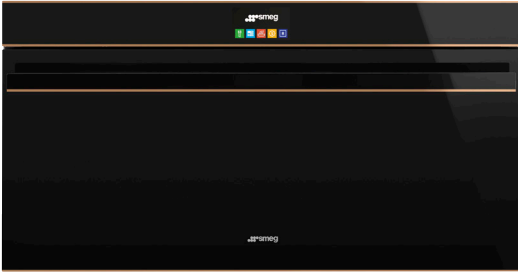

Dimensions	896mmW x 571mmD x 475mmH
Power	220-240V, 50/60Hz 3300W 15A Connection
Warranty	Five years parts and labour

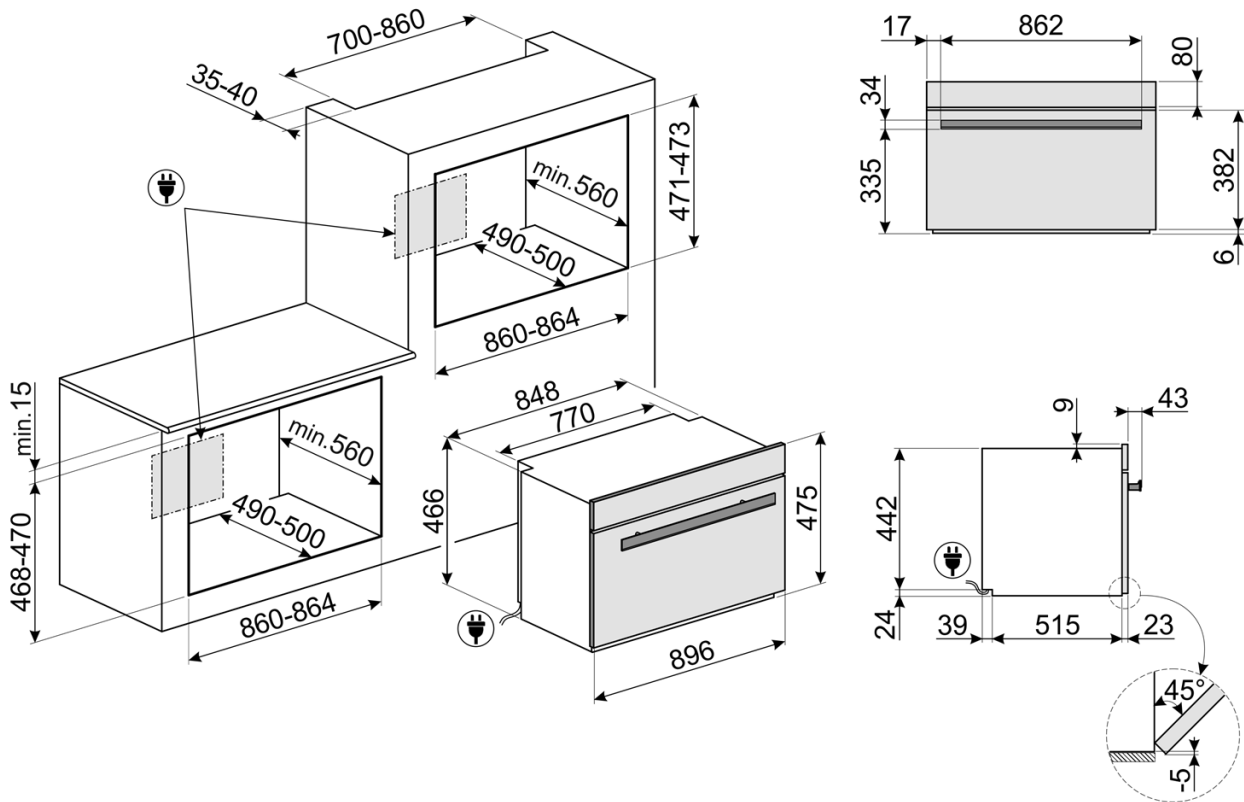

PLEASE NOTE: drawings are not to scale. They are to assist only.
 WARNING: technical specifications and product sizes can be varied by the manufacturer without notice.
 Cutouts for appliances should only be by physical product measurements. The above information is indicative only.